

技术参数:
 产品类型: 耳轴安装型
 缸径: 100
 活塞杆直径: 50
 行程: 500
 丝杆规格: 3205
 安装电机型号: 130ST

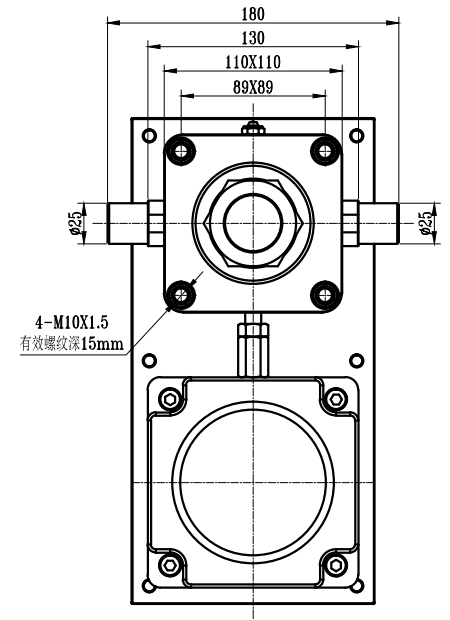

此处电机安装面板会根据电机规格来确认尺寸, 细节尺寸请参照3D