

技术参数:
 产品类型: 耳轴安装型
 缸径: 63
 活塞杆直径: 40
 行程: 450
 丝杆规格: 2005
 安装电机型号: 80ST

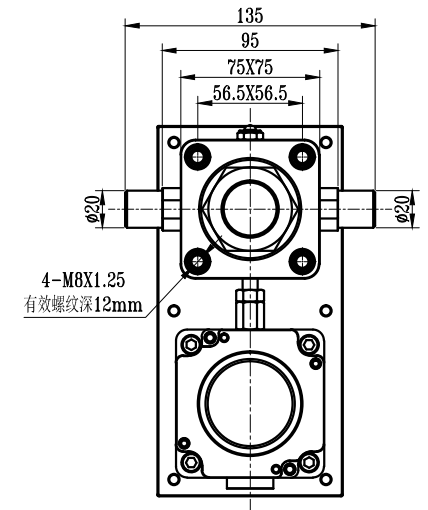

此处电机安装面板会根据电机规格来确认尺寸, 细节尺寸请参照3D